

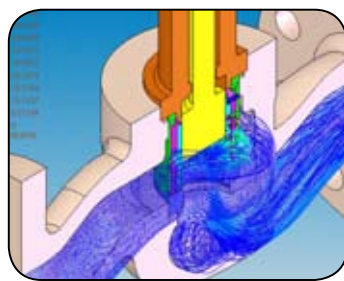

Mechanical Design Service

- Mechanical Design, Development and Implementation
- Custom-Made Mechanical Systems to Suit Application
- Advanced PLC Automation and Process Integration
- Product Development, Production, Testing and Commissioning

- Advanced 3D CAD Modeling and Finite Element Analysis
- Production / Assembly Drawings and BOM
- Online Engineering Register and Revision Control
- Legacy Data Conversion (Paper / 2D to 3D CAD)

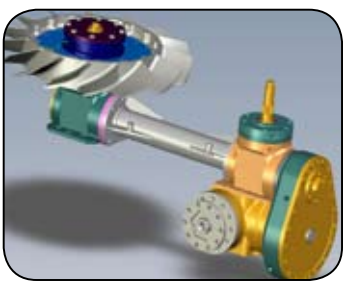
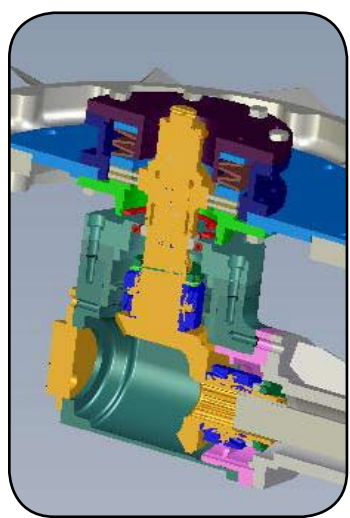
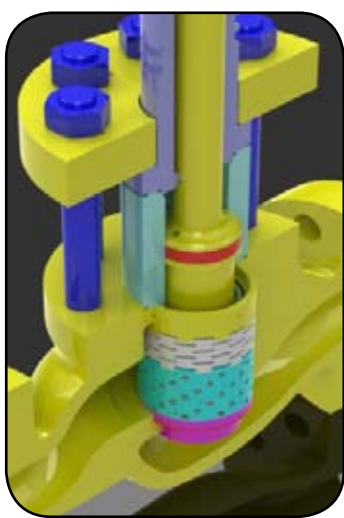

Reconeng Industrial Engineering is the leading provider of mechanical design services, providing Australian and Overseas clients with innovative engineering solutions based on **design experience spanning more than 30 years.**

Focus on your customers safe in the knowledge that our high-level development capabilities and our supplier resources of the World will provide you with **time and money saving solution every time.**

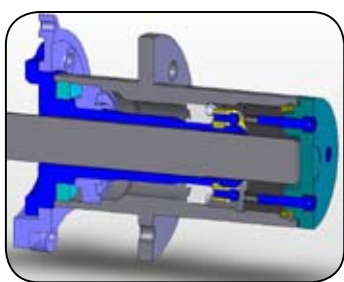
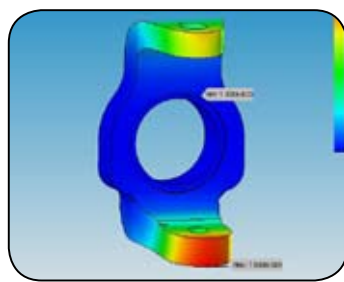
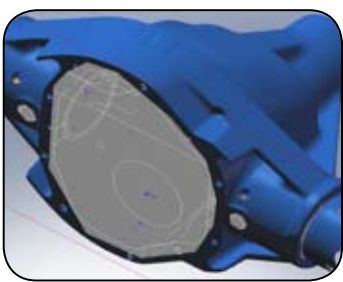

- High-level integrated 3D design
- 5,000+ component dynamic assemblies
- Formed, molded, milled die-cast, extruded, sheet-metal, welded components
- Production and assembly drawings and BOM
- Internal quality control system
- Three-tier independent design, checking and approval process
- Designs of the highest technical standard

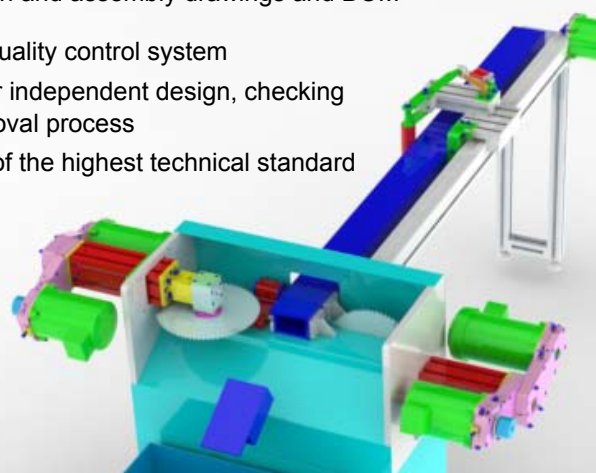
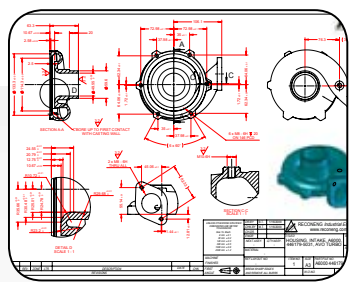
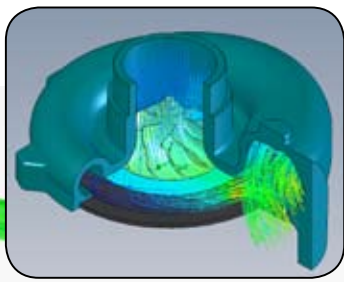

30%

Take advantage **NOW** of the **30% TAX DEDUCTION** on all machine purchases

Once a product is designed, bringing it to reality requires a whole new engineering process with its own unique challenges. Our full-cycle, integrated product development capability (from design to commissioning) saves you time and money.

Large, small, simple and complex, mechanical design and project implementation is what we do at Reconeng everyday.

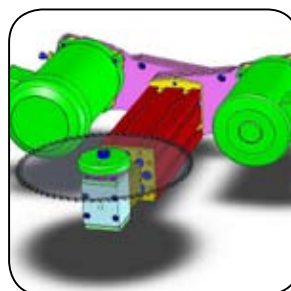
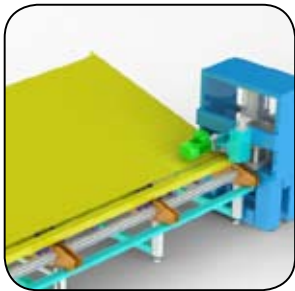
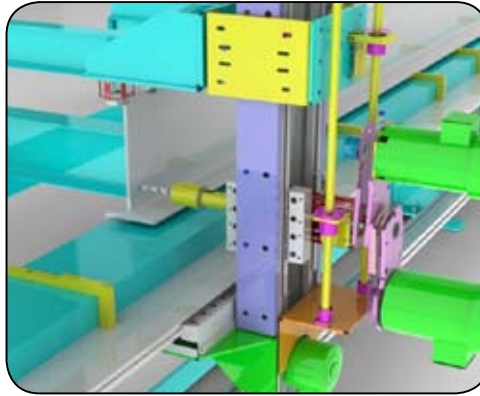

- Full-cycle design development (from concept to prototype, testing and production)
- Full project management, electrical and mechanical testing
- PLC production automation and process integration
- Custom-made machine-tool applications specialty (cutting and drilling)

- Full FTP internet file exchange facilities
- Quick design communication with clients anywhere in Australia
- Online maintenance and revision control of Client drawings and registers

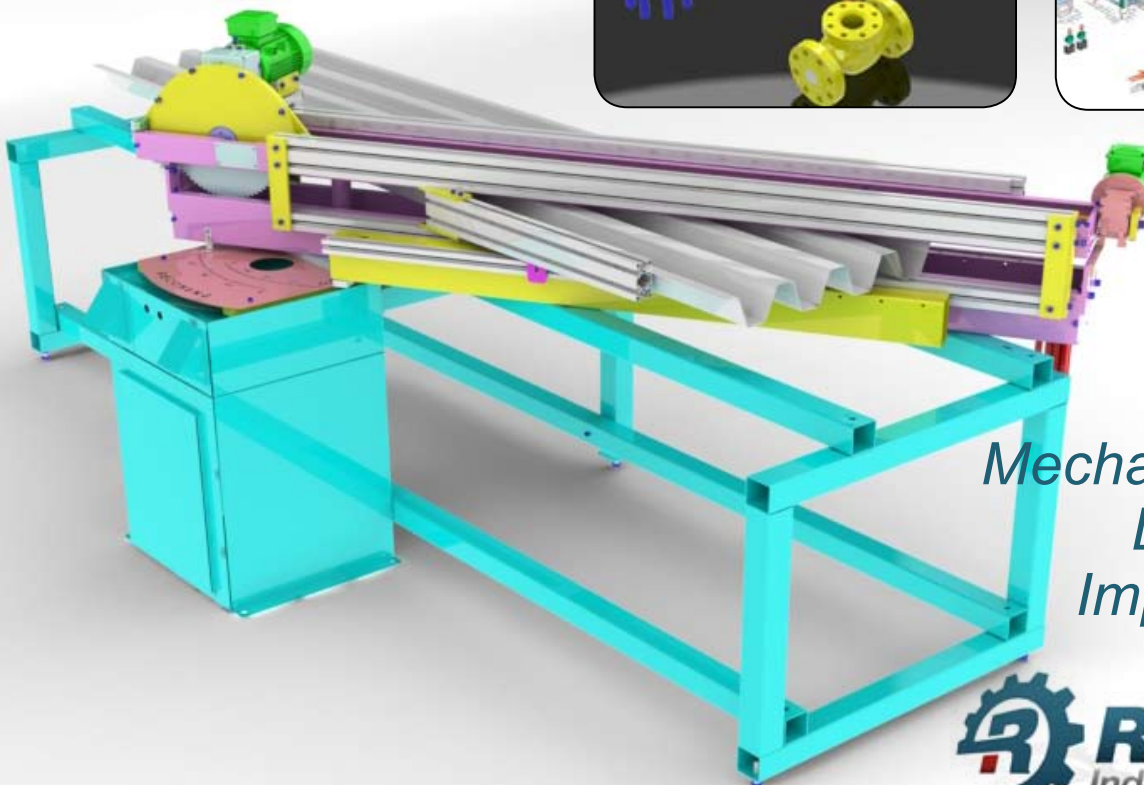
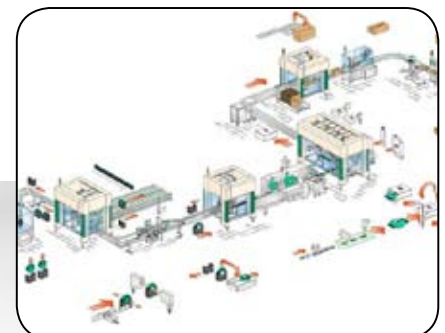
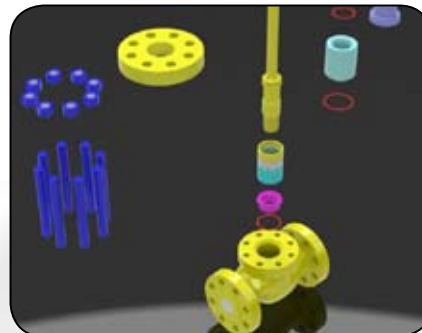

*Mechanical Design
Development
Implementation
Innovation*



18 Jeffrey Street Dandenong VIC 3175 AUSTRALIA

T +61 3 9793 9358 F +61 3 9793 9308

reconeng@reconeng.com.au

www.reconeng.com.au